



Solutions for Mining



The WEG Group



WEG is a global company providing complete solutions for the mining industry, services and customized products designed in compliance with international standards and specific customer needs. With more than 31,000 employees worldwide, WEG provides not only machines that work harder, better and longer, but products which are supported by our global presence assuring fast after sales support. WEG has a network of distributors and representatives in 29 countries and manufacturing is represented on all 5 continents. **All WEG customers in the mining market have a long-lasting relationship with the company due to the commitment that WEG has to their projects and to keep their mining plants operating.**

Whenever you need a **reliable supplier** of products for **mining applications, count on WEG!**

WEG Serves You Globally

Our global structure allows us to be closer to our customers. Over 32 subsidiaries established in key countries are prepared to provide you with technical and commercial support; our manufacturing plants strategically located in the main markets can serve you with short deliveries; and our network of over 1,250 Authorized Service Agents located on five continents are fully equipped to give you prompt sales and service support.



Global Presence

WEG at a Glance

- US\$ 3.3 billion yearly turnover (2014)
- Manufacturing plants in 11 countries
- Over 31,000 employees

Global Product Certifications

 Argentina	 Australia	 Brazil			 Canada	 China			
 Colombia	 Europe				 France	 Germany			 Global
 India	 Italy	 International	 Japan	 Mexico	 Netherlands	 Nigeria	 E.U.A.		
 Russia Kazakhstan Belarus	 Russia	 Saudi Arabia	 South Africa	 South Korea	 Suíça	 UK			

Electrical Package for

A typical mining environment is notorious for being one of the harshest working environments on the planet. Critical ambient conditions, solid contamination (dust) and severe processes are just some of the major factors present at a mine site. By tailoring an individual solution for the mining industry, WEG is able to effectively lower the total cost of ownership, while assuring reliability in operation.

WEG's electrical products allow your plant to be a flexible, safe and reliable facility with operational stability and highest possible production levels.

- Electrical packages including E-houses, LV and MV panels, switchgear, switchboards, contained and mobile substations, SCADA systems, and power transformers, among others.
- LV/MV electric motors with variable speed drives for material handling (overland conveyors, in-plant conveyors, reclaimers, Bucket-Wheel Excavator-BWE), crushers, flotation cells, geared and gearless slurry pumps and mill pumps, sea water lift, high pressure pumps (desalination plants), etc.
- Mill drives solutions such as low speed synchronous motors with drives for dual or single pinion mill configurations, wound rotor induction motors and liquid rheostat starters, even inverter duty squirrel cage induction motors.

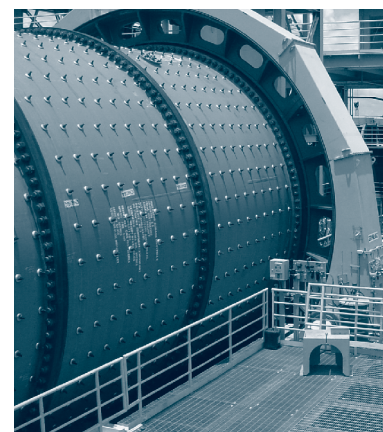
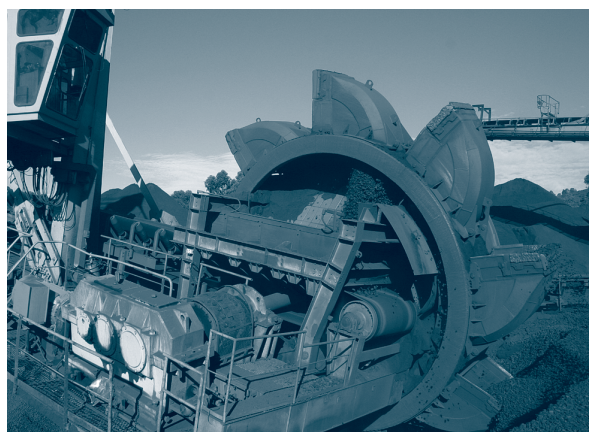
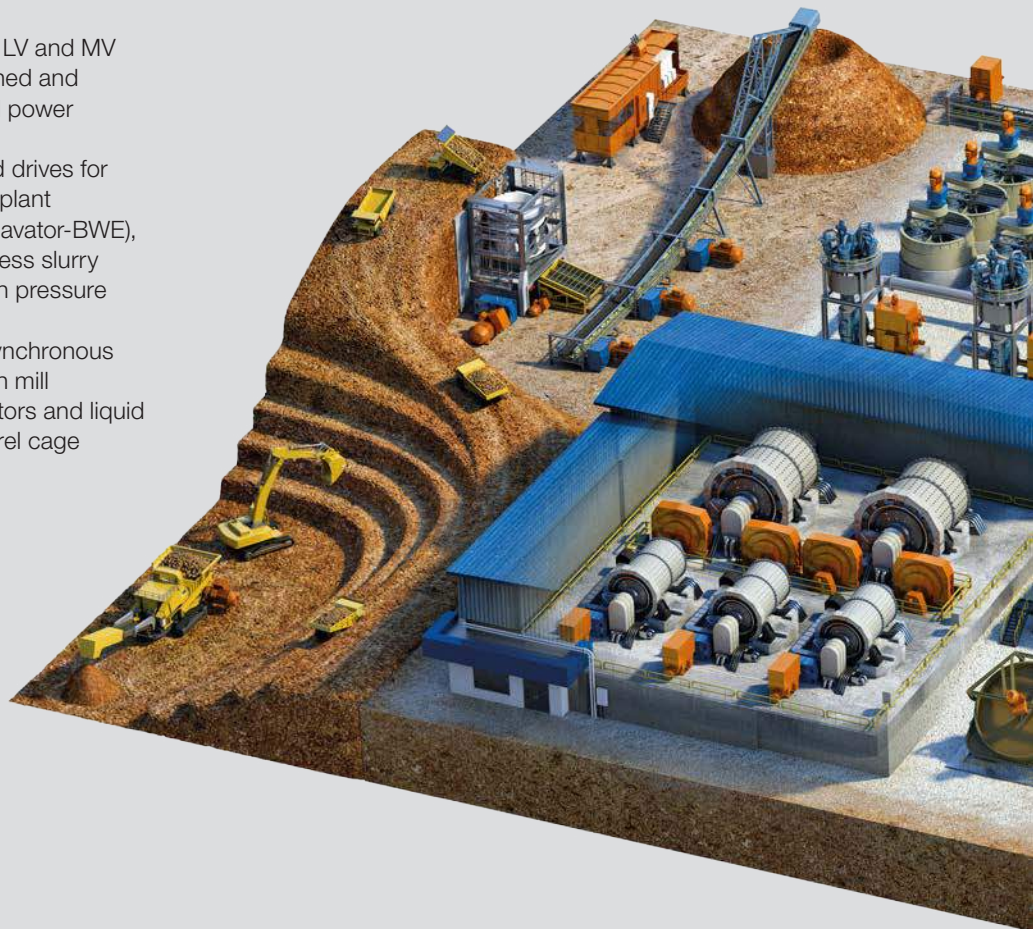

Mining Plants

The combination of **skilled staff, industry expertise and continually updated manufacturing methods and processes, in addition to high-tech R&D and laboratories,** ensure that WEG products are suited to the widest range of applications and operating environments worldwide.



“WEG products are suited to the **widest range of applications** and **operating environments** worldwide.”

Grinding & Concentration



Mill Drive Systems

WEG's experience with Mill Drive Systems brings mine operations the most reliable and efficient products for grinding facilities for ferrous and non-ferrous assets.

In the heart of a concentration plant, the balls and SAG mills must be driven by a solution package that fits the mineral characteristics complying with the whole process. Fixed or precise variable speed, high starting torques, different types of couplings and cooling systems, whatever is needed, WEG has a solution among the wide range of electrical products such as large MV Motors and Drives, Transformers and Switchgear.

With the mines constantly reducing their material grades, higher volumes have to be processed. To meet this requirement, mills must have flexible drive systems in order to minimize downtimes. WEG can offer the right drive system for the toughest requirements for the main mill manufacturers.

- Slip ring/Wound Rotor Induction Motor (WRIM) + liquid rheostat starter (supplied by others) and associated electrical equipment: switchgear, slip energy recovery (supplied by others)
- Low Speed Synchronous Motor (LSSM) direct coupled to mill pinion (without gearboxes) and starting direct-on-line (pneumatic coupling) or by MV VFD's for variable speed applications
- Squirrel cage induction motors + MV Variable Frequency Drive and associated electrical equipment: phase shift transformers, switchgear, E-houses
- Squirrel cage induction motors + MV VFD for HPGR mills with refined speed and torque control

Global References



Codelco Teniente
Single Pinion Ball Mills - LSS Motors (Retrofit)



United Taconite LLC - Minnesota USA
Dual Pinion SAG Mill - 2x LSS Motor + Airclutch Load Sharing System



Potrerrillos Codelco Salvador - Chile
Single Pinion Ball Mill - SCIM + MV VFD



Everest South Platinum Mine
Single Pinion Mills: WRIM with Brush lifting device + Liquid Rheostat Starter



Fixed Speed

Low Speed Synchronous Motor

Synchronous motors are also widely used in fixed speed mill drive systems with the use of air clutch between the Motor shaft and Mill pinion to provide a smooth starting method. Use of the synchronous motors can also provide power factor correction with external field excitation, it can be designed with a high number of poles, achieving rated speed directly to the mill pinion without use of large and expensive gearboxes.

In addition to efficiency levels, the power factor correction, high torques and low starting currents, constant speed under load variations, low operating and maintenance costs are the main reasons why WEG synchronous motors are used for Mill Drive systems.

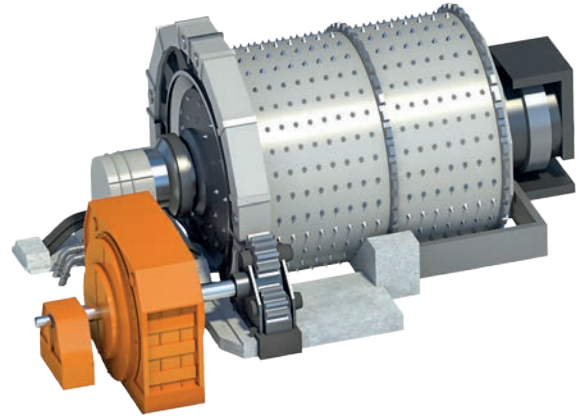

Induction Motors

For Dual or Single Pinion Configuration of Ball and SAG Mills, the Wound Rotor Induction Motors (WRIM) are commonly used when fixed speed and low inrush current are needed.

WEG Induction motors (Master Line) are designed with air (Totally Enclosed Air-Air cooled) or water (Totally Enclosed Air-Water cooled) cooling systems, high efficiency and reliability with 30+ years life span and separated slip ring chamber avoiding possible winding contamination by the brushes dust.

Combined with the operational advantages of the WRIM, WEG developed a motorized brush lifting device which is responsible for the rotor short circuit when the motor reaches its rated speed, taking advantage of high starting torques and low inrush current together with a minimum wear of brushes and slip rings, drastically reducing mills downtimes due to maintenance.

On some speed variation range, Slip Energy Recovery (SER) systems can be used together with traditional starting system (LRS) with the objective of recovering dissipated energy from the rotor circuit towards the main bus bar.

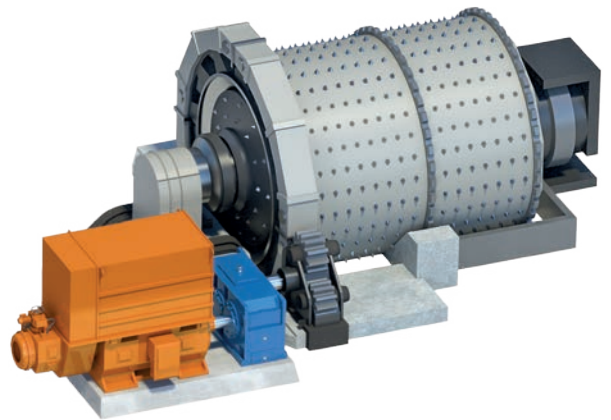



Variable Speed

Dual or Single Pinion Drive Systems

Designed to drive and control the speed of medium voltage motors coupled with Dual or Single pinion SAG, Ball and HPGR Mills, the MVW-01 variable frequency drive uses state-of-the-art technology through a multi-level structure with medium voltage IGBTs, reducing harmonic currents in the motor to extremely low levels. The load sharing feature that operates two MV Drives in a master-slave configuration allows control very large size of mills.

WEG can offer complete Mill drive system for application that requires reliability, very high level of availability easy setup and system updates. Since the input switchgear, oil or dry phase shift transformer, variable frequency drive and Induction or Low Speed Synchronous motor are part of WEG's scope of supply. The configuration of the input rectifier in multi-pulse arrangement, reduces voltage and current harmonics on supply side to be, in full compliance with IEEE 519 Standard. WEG MVW01 VSD operates with 32 bit real time microprocessor and renders accurate speed/torque control for single drive or dual drive control with load sharing.

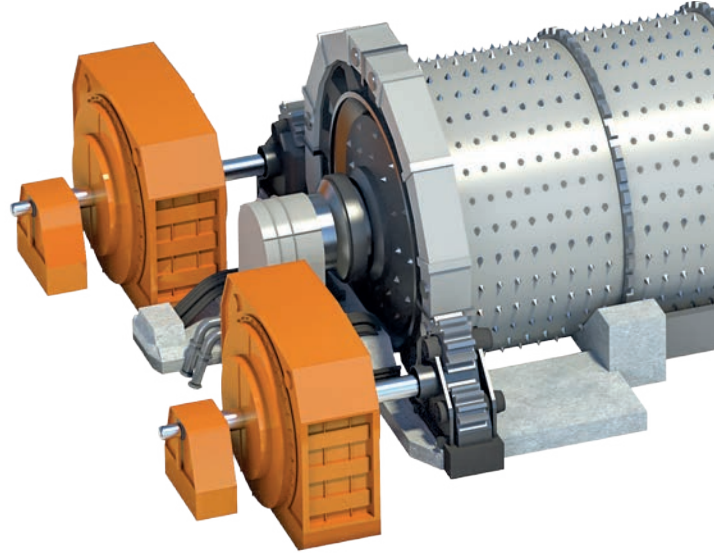

HPGR Mills

For the HPGR Mills, the system can precisely control each induction motor coupled with the rolls in a master-slave configuration.

One of the challenges when specifying the Mill drive system is to ensure the best performance together with the easiest and most reliable process configuration.

Following best practices for mill process control, important mill control functions such as Frozen Charge Detection, Frozen Charge Release, inching control are programmed as part of WEG's MVW01 Drive Control. This eliminates the need for programming and controlling these functions via separate DCS or PLC control.





Slurry Pumps

Concentrator plants have many pieces of critical equipment. Among them, are the slurry pumps for mill discharge and the cyclone feed process.

Traditionally slurry pumps are driven by common squirrel cage induction motors coupled with a gear reducer, (gearbox), in order to reach nominal pump speed. An alternative to this is the gearless drive concept which eliminates the gearbox between the pump and motor, thereby increasing overall efficiency and decreasing cost and time for maintenance.

Cyclone feed pumps and mill discharge pumps driven by a system of a multi-pole squirrel cage induction motors and variable speed drive units optimize the flow of pulp through the system, controlling energy consumption at its most efficient level. To achieve this, the motor's nominal frequency is adjusted to the most efficient operational point based on the torque curve of the specific pump (see graph).

Even though, traditionally configured pumps with gear drive-trains, both centrifugal and diaphragm types, have also been widely installed in numerous mineral concentration plants utilizing WEG's drives and motors solutions.

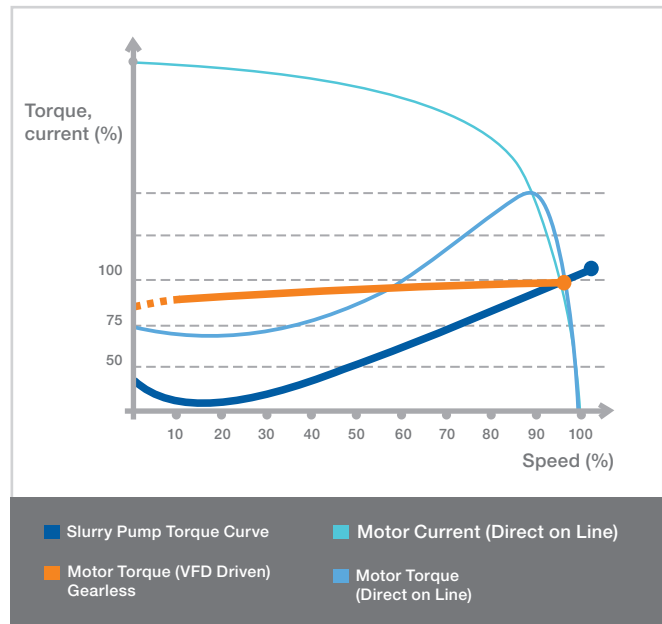

VFD Main Features

- Available per NEMA or IEC standards.
- Sensorless Vector control and Closed Loop Vector Control.
- High voltage (6.5 kV) semiconductors reduces number of components by eliminating use of series connected devices, resulting in higher efficiency and reliability.
- Rectifier input 12, 18, 24, 36 pulse that reduces supply side harmonics.
- Multi-level structure that reduces armonic currents in the output.
- Network communication: DeviceNet, Modbus, Profibus-DP and Ethernet.
- High efficiency (>98.5%) and power factor (>0.95).
- Air cooled.
- Draw-out style power modules (fast and easy servicing).

Motor Main Characteristics

- Rated power, number of poles and nominal frequency are calculated to provide the best cost effectiveness for the system. Once the motor will be driven by a PWM MV VFD, the motor can be set to reach the most efficient point of the pump.
- Force ventilated motors with wide speed range for constant torque operation.
- Motors are generally from 300 kW up to 4,000 kW, low or medium voltage and from 4 to 24 poles.

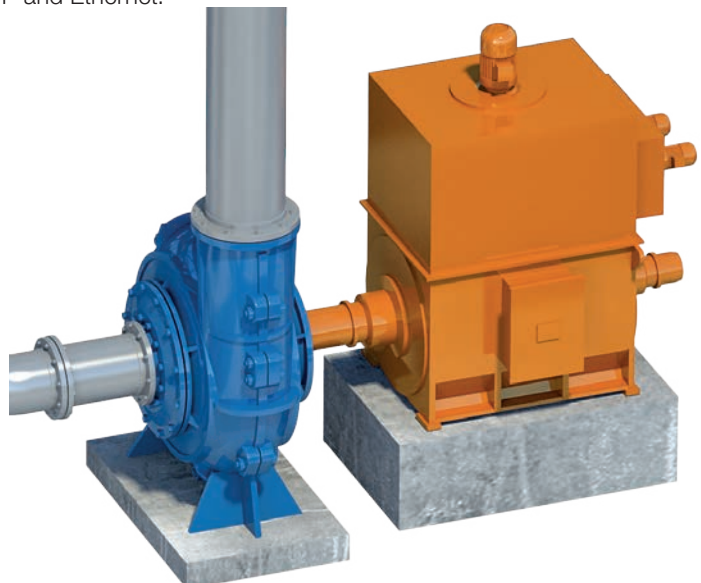



Flotation Cells

WEG products are developed with innovative technology, to improve the efficiency with significant cost savings and to meet the toughest flotation process requirements, helping the mining operations to ensure the best output results.

With high efficiency levels, WEG products are designed to endure the most diverse and stringent environments. The high resistance to chemical abrasion increases the electric motor lifetime in flotation process applications.

Our portfolio includes an extensive line of special products with features such as:

- Special design for a variety of assembling and coupling position (vertical shaft up and pulley belts, vertical shaft down or regular horizontal directly to gearbox)
- Reinforced Shaft dimensioned to support the high radial thrust level
- Oversized roller bearing for pulley and belts coupling system
- Cast iron or steel fan cover
- Cast Iron fan with extra protection against chemical abrasion
- Stainless steel hardware and special painting for extra protection of surfaces

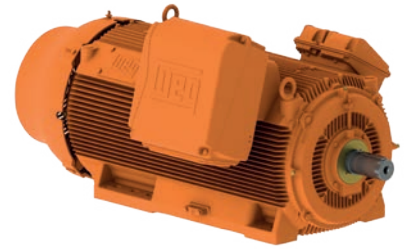

WMining - HGF



W22 WMining for gearboxes



Material Handling



WEG can offer complete package for material handling systems. From the LV motors for small and auxiliary feeders up the state of the art systems for Overland Conveyors, Bucket wheel Excavators, Stackers and Reclaimers. Optimum motor design is done working together with expert internal/external engineering resources and competent mechanical equipment manufacturers around the globe.

WEG Crusher Duty W22 (WMining)

The WEG W22 Crusher Duty motor has been redesigned for even higher performance and energy efficiency, while still retaining all the great features of the WMining.

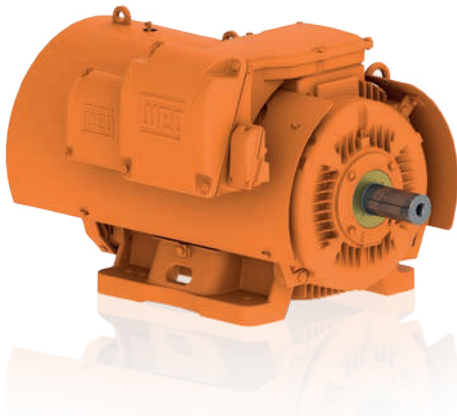

Designed to meet the demanding requirements of the rock crushing industry, the Crusher Duty motor comes standard with 4140 high strength shafts and heavy duty roller bearings.

The high degree of protection IP65/IP66, ensured by the exclusive W3Seal bearing sealing system, extends motor lifetime when operating in aggressive environments by protecting the motor against water and dust guaranteeing proper degree of protection. Large terminal box with more space for connections, high quality shafts, oversized bearings and steel fabricated surrounding mufflers guarantees the proper cooling system operation. All features, including painting plans, everything is designed considering the worst case scenario to supply the most reliable motor for the harshest mining application.

Built to Last

W22 motors are built using high quality FC-200 cast iron, assuring maximum durability and high performance in aggressive conditions. The new fan cover design provides great impact resistance. Additionally the end shields have been designed for a better bearing heat dissipation and structural rigidity. Protected by our WEG coatings high performance paint system capable of passing a 240h ASTM 117B salt fog chamber test.

Lower Total Operational Costs

A product that can operate most of its designed lifetime consuming minimum possible energy, with high levels of reliability, generating maximum value to the user - this is what is behind the WMining motor design.

Inverter Duty Applications

The exclusive WISE insulation system used on the W22 increases winding dielectric resistance, thus allowing VFD operation up to 575 V without requiring further modification, resulting in flexibility and extended motor lifetime. Utilizing class H magnet wire and varnish that exceeds class F requirements.

Stackers



Bucket Wheel Excavators



Stockyard Machines



Overland Conveyor Drive System

Whatever you need on high distance overland conveyor, WEG has the right solution of motors, drives and power systems. User friendliness of WEG's customized solutions maximizes productivity and minimizes maintenance, reducing environment impacts while saving energy.

Systems where concentrated power is needed, wound rotor electric motors are applied whereas liquid rheostat starters are designed to operate in parallel to ensure the same resistance to the motors that share the total conveyor load.

WEG CFW11 Series of variable frequency drives incorporates world's most advanced drive technology for three phase AC induction motors. The Vectrue Technology™ enables the new generation WEG inverters to combine V/F, sensorless and closed loop vector (with encoder) control techniques in one product. The true open loop vector controls allow for high torque and fast dynamic response. Self tuning allows for automatic drive set-up to match the drive to the motor and load in vector modes.

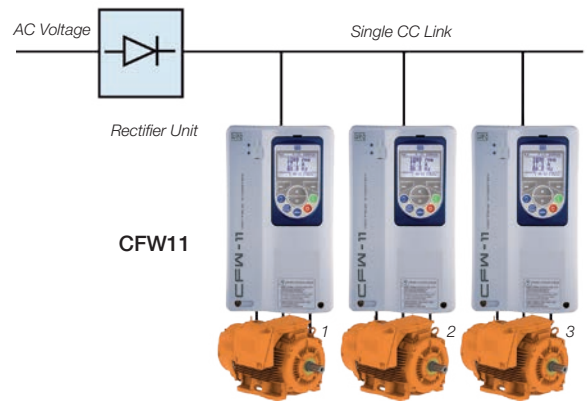

In cases where multi motors is the only choice available: the high length and tons per hour capacity requires placement of drive pulleys at both head and tail. The head and tail drive pulleys are driven by PWM VFD and specially designed electric motors. These arrangements require a Master/Follower co-ordination of head and tail torque and speed control uses most common communication protocols over fiber optic cables. The controls also have to be integrated into the customer automation system and installed in a custom made E-house.

The VFDs are equipped with dead time compensation technique, thus avoiding motor instability and providing increased torque at low speeds.

In high power overland conveyors applications, robust and simple systems using wound rotor motors have demonstrated that they are the most cost effective option.

Such systems allow reliable mechanical arrangements between the drive pulleys and drums along with the load sharing of the motors. The starting processes are normally secured by a LRS (liquid rheostat starter) with connecting tanks, ensuring the same resistance to all motors.

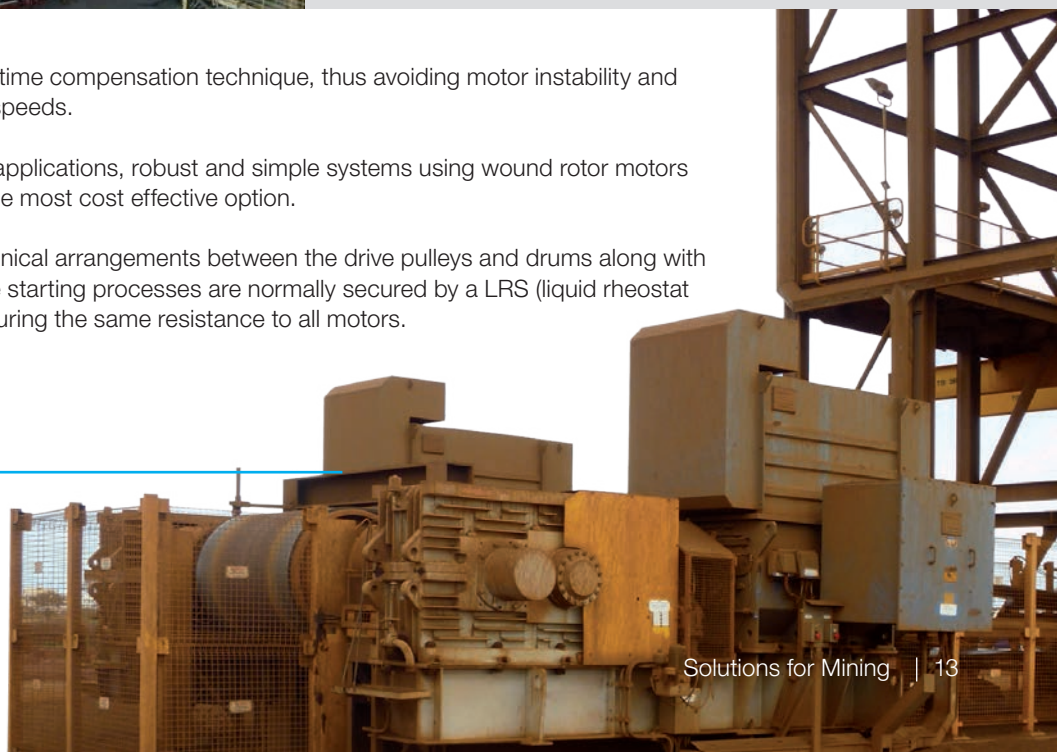

Site Utilities



Mining E-Houses

WEG Container-Type E-houses are designed and manufactured in a modular concept, which provides flexibility to meet the requirements of a wide range of applications.

Assembled in a single platform, the E-house integrates the electrical and control systems of the mining processing plants, therefore the need for costly, permanent structures is avoided. These designs are customized, achieving and surpassing the critical mining needs such as geological vibrations, wind and flame resistance.



Secondary Substations

- It replaces traditional concrete fabricated rooms, saving space and time in the assembling process or civil works.
- Double wall with thick plate (1.5-2 mm), providing greater toughness and lifting process thru the base.
- High quality thermal insulation ensuring power efficiency of the air conditioning system.
- Can be installed directly onto material handling machines (stackers, reclaimers, bucket wheel excavators).



Mobile Container-Type E-Houses

- Mobile Container-Type E-houses with Wheels equipped with transformers (oil or dry-type).
- Especially designed for Underground Mines with special coating for humid environments and high ore and dust concentration.
- Inverters and soft-starters can be installed to start and control fans, pumps, crushers and conveyors.
- Higher degree of protection for all panels.



Semi-Mobile Container-Type E-Houses

- Semi-mobile: avoid the use of cranes to lift and handle the unit, since rooms can be lifted with mechanical, hydraulic or pneumatic support devices.
- Installation directly on the ground; no base is required.
- Onboard transformer, dry or oil cooling type;
- Special WEG coating resistant to the toughest environment.
- The electric rooms can be fitted with fire extinguishing system, access control, CCTV and UPS.

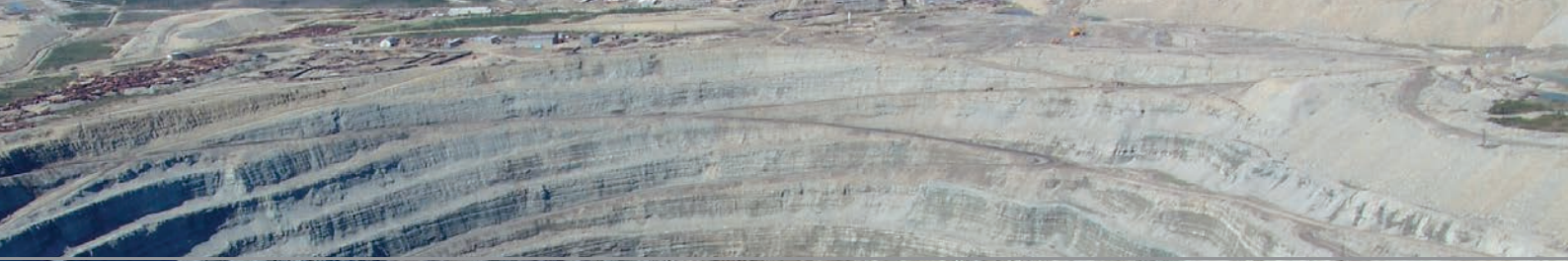

Excellence in Power Supply Technologies

Excellence in power supply technologies associated with the use of high quality raw material and product customization differentiate WEG's supply of Transformers and Substations for the Mining Industry.

Over 35,000 MVAs per year represents the reliable manufacturing capacity of WEG in the area of transformers, substations and high voltage power transmission and distribution equipment. This capacity is the result of a vertically integrated production process, providing flexibility and short time delivery.

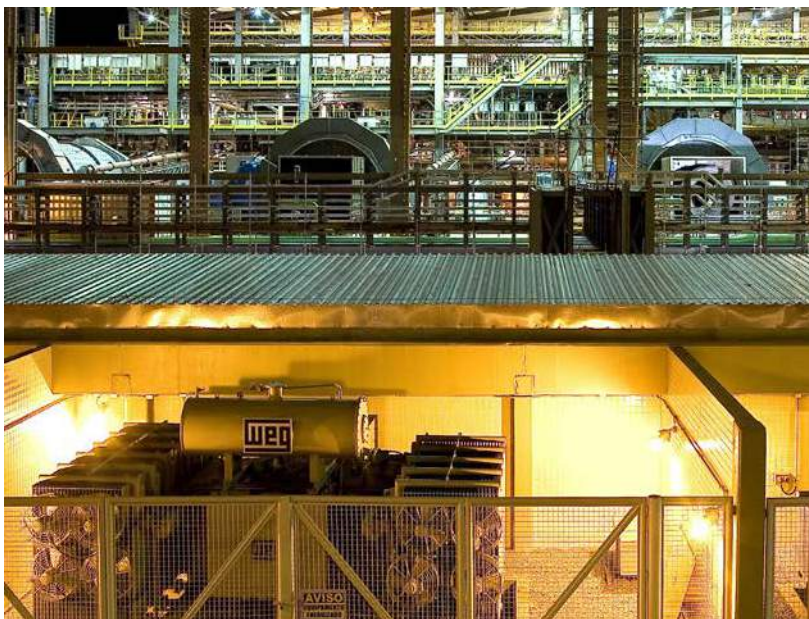

Power Transformers

Reduction in weight and dimensions, variety of insulating oils, longer lifespan and monitoring systems are just some of the items evaluated by WEG's technical team to develop oil transformers that offer top level solutions to its customers. The portfolio includes a complete line of distribution and power transformers up to 550 kV, insulated with mineral oil, to reduce the equipment cost, or vegetable oil, to reduce significantly environmental impacts.

Conventional Substations

The substation division counts on a qualified and experienced team of engineers which are in charge of the development and design of turnkey substations - from prospecting, defining a specific solution to the customer, managing the project, to manufacturing and assembly. It has proven experience, having already delivered and powered over 350 substations in voltages up to 550 kV.



Mobile Transformers and Substations

Developed with the most advanced components in the market, the Mobile Solutions (Transformers and Substations) ensure dynamic operation and agility, easily installed wherever required. They are used for emergencies and scheduled maintenances in power transformers and substations, allowing the jobs to be carried out without interrupting the power supply.



Efficiency and Reliability on Automation System for Water Supply

Advanced built-in technology for speed variation; compact solutions for short-circuit protection and overload conditions; high short-circuit breaking capacity; reliability and precision in monitoring, operation and protection of Electric motors, WEG supplies solutions to control the water supply, desalination plants and pump stations for mining projects.

Employing on a team of senior engineers with extensive market and design experience, WEG is recognized and certified as a manufacturer and supplier of variable speed drives, soft-starters, motor control centers, motor starters, motor circuit breakers and an extensive series of motor control and protection products for pump applications.



Desalination Plant in Algeria

Estimates show that in 30 years the amount of water available per person in the north of Africa will be reduced to 80% from what is currently available. As a result, the Algerian government invested in a plan for seawater desalination. This includes the construction of three large desalination plants with production capacity of 400 cubic meters (106,000 US gal.) of water per day which will greatly benefit a population of over 2 million.

The Tlemcen-Honaine plant, located near the city of Oran, close to the border with Morocco, has a production capacity of 150 thousand cubic meters and will supply 750 thousand inhabitants directly making it one of the largest in the world.

WEG supplied 17 x Soft-Starters and 10 x VFD's for the pumps that will withdraw water from the Mediterranean Sea at Honaine. US\$ 400 million was invested in the three plants.

In addition to the desalination plants, the resources will also be used in the construction of dams and for sanitation. According to Daho Ould Kablia, "with the new program, the Algerian government intends to find a balance between the different regions of the country and provide a fair supply and distribution of water and the services related to it".

In general this reality has been noted in many mining projects. As environmental regulations become more stringent, mining companies are facing significant water challenges. Desalinated water is proving a vital solution when fresh water is a common need between local population and mining facilities.



Pump Stations

From the coldest to the hottest temperatures, corrosive atmospheres or globally unstable conditions, WEG's solutions reduce maintenance to a minimum, while lasting longer and helping to improve efficiency on Pumping Systems.



W50 High Voltage Motors

The WEG W50 motor line is a product designed for industrial applications ensuring high performance and reliability even under the most severe operating conditions. The W50 motor complies with the strictest criteria of efficiency and safety.

- New frame design ensuring maximum performance between mechanical rigidity and thermal dissipation, thereby reducing motor vibration and increasing lifetime.
- Unique fin distribution design which ensures excellent thermal performance.
- The mounting system of the grid and internal baffle ensures low noise levels, even lower than noise levels established by standards.
- A high performance and robust product with a compact design.
- Low vibration levels which increase lifetime.
- WISE insulation on low voltage motors and VPI insulation for high voltage motors which increases stator electrical strength.
- Motor can be provided with sleeve bearings, wide range of accessories, modular blower kit, oversized terminal box and others.

Characteristics

- Output power: 75 up to 1,250 kW
- Rated speed: up to 5,000 rpm
- Frame sizes: 315 H/G up to 450 J/H
- Frequency: 50 Hz and 60 Hz
- Voltage: 380 up to 6,600 V
- Number of poles: 2 up to 12
- Available per NEMA or IEC standards

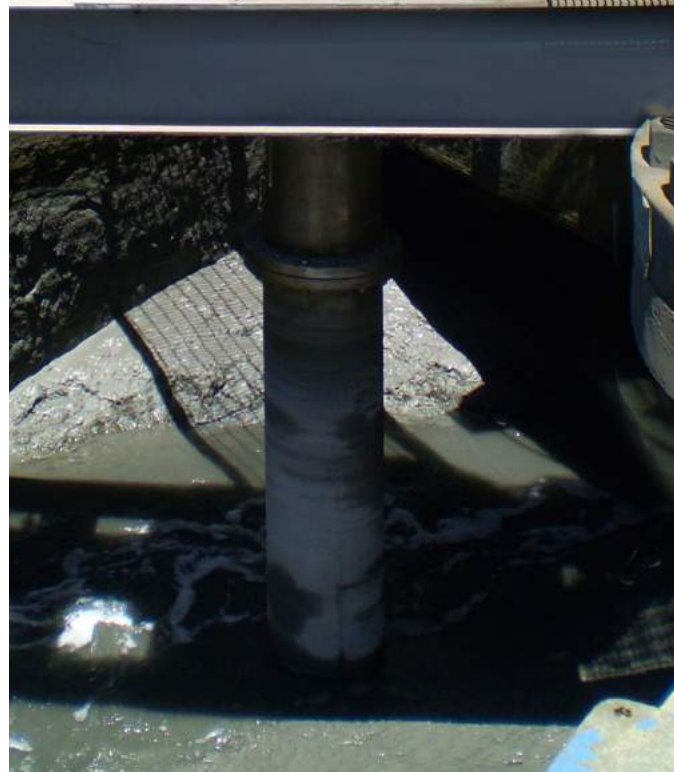

Coatings



Coatings Providing Full Protection

WEG offers to the mining segment the most advanced technology in coatings that ensures maximum anti-corrosive protection and long durability, which reduces maintenance and provides excellent finishing with high performance, less environmental impact due to low VOC (Volatile Organic Compounds), and excellent cost effectiveness.

Primers and Double Purpose

WEG EPOXY primers are developed to meet the widest range of requirements:

- Environments that require high chemical and abrasion resistance, high-solids for greater coverage and thick coat application for greater productivity.
- Flexibility during application regarding surface preparation in places where it is not possible to perform abrasive blasting.
- Surfaces with treatment by abrasive blasting, hydro blasting, and manual or mechanical treatment.
- For environments with great presence of residual humidity or applications where the relative humidity is above 85%.
- Products that meet high safety standards.

Special Products

WEG Tar Free WT - Two-component, high build epoxy primer, with excellent chemical and anticorrosive resistance, and higher abrasion resistance.

WEG Fenóxi - High build phenolic epoxy Primer/topcoat with high resistance to chemicals and abrasion; resistance above conventional epoxies.

WEGPOXI Wet Surface 89 PW - Epoxy Primer suitable to be applied on humid surfaces. Metallic aluminum version offers greater protection by barrier.

WEGPOXI N2912 Type III - Two-component high build high solids Novolac epoxy primer. Extremely low content of volatile organic compounds (LOW VOC) formulated with glass flakes, providing excellent corrosion protection, in addition to great resistance to abrasion and impact, as well as excellent surface hardness and impermeability.

Topcoat Options

WEGTHANE HBA 501 and HPA 501 - Fast-drying aliphatic acrylic polyurethane topcoat applied in high thickness (50 to 125 microns) with excellent color retention for long periods (Topcoat for high temperatures up to 600 °C).

Zinc and Aluminum Silicate N 2231 - Primer/Topcoat with cathodic protection (zinc) and by barrier (aluminum).

WEGTERM CVA 660 Alumínio - Aluminum Silicone Topcoat.



Services



Services and Support with the quality of WEG products

Protecting your investment means more than insuring the plant. It also means keeping your equipment in top condition to maximize service life. That's why you can count on WEG - the responsive company with comprehensive rotating equipment services and support.

WEG has earned a reputation for quality by supporting our customers with specialized technical product and services, and our ability to respond promptly to customer demands. Excellent service is assured by people who understand your equipment and process needs. Our experienced staff of service engineers can spot potential performance problems and recommend corrective action.

Continue to enjoy the benefits of first-hand product knowledge and problem solving capabilities by having us train your on-site staff. We can recommend ways to improve your equipment life time and maximize your equipment availability. With that in mind, WEG is pleased to present the following key benefits that will bring a safe and reliable operation for the electric motors in the most remote and toughest environmental conditions.

Retrofitting and Repowering Service Ranges

WEG also have the same facilities structure and standards to perform retrofitting and repowering services, extending the large equipment life time.

- DC generators and motors up to 10,000 kW
- Three-phase induction motors up to 50,000 kW
- Synchronous motors up to 90,000 kVA
- Turbogenerators up to 150,000 kVA
- Power transformers voltage rate up to 550 kV



Energy Efficiency

Identification of potential reduction of power consumption in electric motors, drives and deviations in the power factor, proposing solutions and defining the necessary retrofit. Results presented with individual return deadlines, making the decision flexible.

Recoverability Limit

Definition by means of technical and economic criteria of the feasibility to repair or replace the electric motors.

The work is performed with the help of a specific software application, analyzing the data of each plant, allowing the cost analysis of the life cycle of the motors.

Commissioning and Start Up

Bearing in mind the magnitude of the mining projects and complexity of the installed equipment, WEG offers specialized technical support for the installation, from beginning to end including supervision services. Also included is verification of equipment details and concept integration with the entire system.

Project Management

Complex mining projects usually require very strict control of technical documents, production schedule, inspections and logistic procedures. In those cases WEG offers dedicated staff structure to support tasks at different stages of the project execution. With these initiatives WEG provides clear and up to date information on the equipment manufacturing stages and keep all parties involved informed on the production and delivery progress.

Preventive Maintenance

Checkup and preparation of preventive plans according to maintenance concepts focused on reliability and adjustments according to operating conditions for each plant.

WEGINMINING 2007-2014

Canada

- Eleonor - Goldcorp
- Jansen Potash - BHP Billiton
- Legacy Potash
- Cigar Lake - Cameco Uranium
- Chibougamau - Stornoway Diamond
- Osisko (Gold Mine)
- Kidd Creek Copper - Xstrata
- Detour Lake Gold
- Young-Davidson Matachewan
- Mont-Wright Mining Complex
- ArcelorMittal
- Bloom Lake - Cliffs Natural Resources
- Newmont Leeville - No 3 Vent Shaft
- Bracemac-McLeod

USA

- Hycroft Expansion
- Project Allied Nevada
- Morenci Mine - Freeport McMoran
- Mesabi Nugget LLC
- United Taconite
- Empire Iron Mine/ Cleveland Cliffs Iron
- Essar Steel - Minnesota

Mexico

- Buenavista del Cobre - Cananea
- El Gallo Complex A-G Gold-Silver Mine & Mill
- Rey del Plata - Peñoles
- San Julian - Peñoles
- Velardena

Kazakhstan

- Bozshakol Copper Project
- Aktogay

Mongolia

- Tsagaan Suvarga

Saudi Arabia

- Ras Az Zawr Aluminium Complex/Maaden

Russia

- Severstal

Ukraine

- Poltava GOK

England

- Hemerdon Tungsten

Finland

- Kevitsa Nickel

Guatemala

- Escobal - Tahoe

Colombia

- Cerro Matoso

Peru

- Toromocho Greenfield
- Constanca
- Inmaculada Hochschild
- Las Bambas
- Antapacay
- Xstrata Tintaya
- Minera Condestable
- Cerro Corona/Goldfields
- Bayovar/Vale
- Piura Plant Line I

Chile

- Codelco División Andina Phase I
- Codelco División El Teniente - Concentrator Modernization
- Codelco División Minera - Ministro Hales Greenfield
- Minera Sierra Gorda
- Anglo American Desarrollo - Los Bronces
- Antucoya
- Collahuasi Phase II
- Los Pelambres Tranque El Mauro Expansion
- Gaby Greenfield Project - Codelco
- División Gabriela Mistral
- El Abra Sulfox
- Codelco División El Salvador - Caliza Plant
- Cerro Negro Norte - CMP
- Minera Escondida - OLPAD Dynamic Leach Pad
- Minera Escondida - Organic Growth Phase I
- Carmen de Andacollo Hipogeo/Teck
- Esperanza/Antofagasta Minerals
- Lomas Bayas/Xstrata Copper
- Codelco División Chuquibambilla - Proyecto Quinto Molino

Mauritania

- Tasiast/Kinross

Suriname

- Merian Gold - Surgold

Mali

- Syama Gold

Ghana

- Noble Gold Bibiani

Armenia

- Geopromining Gold

DRC

- Boss Mining Copper

Cote d'Ivoire

- Agbaou Gold

Mozambique

- Moatize - Vale

Namibia

- Husab Uranium

Zambia

- Kansanshi S3 - First Quantum

South Africa

- Burnstone Gold Mine
- Anglo Thermal's Zibulo Coal Mine
- Boteti Mining
- Mopani Copper

Brasil

- Porto Pecem Ship Unloader & Conveyor
- Pier IV - Conveyor 5 - Vale São Luis
- Serra Azul - MMX
- Araxa - Niobium Mine Expansion
- Samarco
- CVRD Cadam - Para
- CVRD Vitoria
- S11D - Vale Carajás
- Isomonte /Anglo Ferrous
- CBMM

Argentina

- Veladero Barrick
- Lindero
- Alumbra

Australia

- Olympic Dam
- Cloudbreak Iron Ore
- Herb Elliott Port/Portecue
- Karara Iron Ore/Gindalbie
- Worsley Efficiency & Growth
- Sino Iron Ore/CITIC
- Christmas Creek Stage I & II
- Solomon Iron Ore
- Grande Cote
- Pajingo Mines
- Duglad River
- Sinclair Nickel
- Alcan Gove
- Prominent Hill
- Arrium Onesteel
- Mt Arthur Coal - MAC20 - BHP
- Queensland Alumina
- Abbot Port
- Port Pirie
- Alcan Weipa
- Keysbrook Mineral Sands
- Gemco
- Metropolitan Colliery
- Grange Resources
- FMG North Star - Stage I
- Sedgman Mungari Gold Project - VSD's
- Sandfire Resources - DeGrussa Copper
- Sunrise Dam Gold Mine - AngloGold Ashanti
- Western Turner Syncline - Rio Tinto
- Roy Hill

Sustainability

Sustainability has been an integrated part of WEG's philosophy since its foundation. That is why awareness of environment protection has been a major concern in the company for the correct use of natural resources and the application of efficient energy solutions.

It is understood internationally, that the effective use of electric power significantly reduces environmental impacts with further cost savings and improved living standards.

This is the path followed by WEG's continuous investments in technological innovation as well as development of premium efficiency electric motors and electronic products which are suitable to operate under increased performance, high productivity, low power consumption, and reduced operational costs providing outstanding benefits to its customers and to the environment.

Along its successful history, energy has been the company's focus while manufacturing reliable and highly efficient products that contribute to a global sustainable development.

Think Green.



We can't **predict** the future, but **we can see** it coming...



www.pamensky.com

WEG Canada / V.J. Pamensky offers the following products, & more! With a full range of IEC/NEMA Global Certifications and a full line of products, WEG Canada can supply the right solution for your needs anywhere in the world. To learn more about WEG's products & solutions or to locate a Distributor near you, please call 1-877-PAMENSKY or visit www.wegcanada.com.

Low Voltage Motors,

Single and 3-Phase, 1/8 – 700HP

- General Purpose Motors
- Explosion Proof Motors
- Crusher Duty Motors
- IEC Tru-Metric Motors
- Pump Motors including JP/JM
- P-Base Pump Motors
- Oil Well Pumping Motors
- Pool & Spa Motors
- Brake Motors
- Compressor Duty Motors
- Farm Duty Motors
- Poultry Fan Motors
- Auger Drive Motors
- IEEE 841 Motors
- Stainless Steel Wash Down Motors
- Saw Arbor Motors
- Cooling Tower Motors
- Commercial HVAC Motors
- Pad Mounted Motors
- Vector Duty Motors

Large Electric Motors

- Low Voltage 3-phase motors up to 2,500HP
- Motors up to 70,000HP and 13,200V
- Wound Rotor Systems (including starters) up to 70,000HP and 13,200V
- Synchronous Motors up to 70,000HP and 13,200V
- Explosion proof motors (Ex-d) up to 1,500kW and 11kV
- Ex-n, Ex-e, Ex-p motors

Variable Frequency Drives

- Low Voltage 1/4 to 2500HP, 230V – 480V
- Medium Voltage 500-8000HP
- Multi-pump systems
- NEMA 4X
- Dynamic braking resistors
- Line and load reactors
- Plug and play technology
- Network communications: Profibus-DP, DeviceNet, Modbus-RTU
- PLC functions integrated
- Complete line of options and accessories

Soft Starters

- 3-1500HP
- Oriented start-up
- Built-in bypass contactor
- Universal source voltage (230-575V, 50/60Hz)
- Network communications: Profibus-DP, DeviceNet, Modbus-RTU
- Complete Line of options and accessories
- MV Soft-starter 3.3kV, 41.6kV: up to 3500HP, Withdrawable Power Stacks, & 8x PT100 Temperature monitoring

Controls

- Mini – Contactors
- IEC Contactors
- Thermal Overload Relays
- Manual Motor Protectors
- Molded Case Circuit Breakers
- Smart Relays
- Enclosed Starters: combination & non-combination,
- Pushbuttons & Pilot Lights
- Timing & Motor Protection Relays
- Terminal Blocks

Custom Panels

- Custom configured to your specification.
- NEMA 1, 12, 3R, 4 and 4X cabinets
- Quick delivery of preconfigured drives and soft starters
- UL 508 certified
- Low Voltage (230-460)
- Made in the U.S.A.

Generators

- Brushless Synchronous Generators for diesel gen-sets up to 4,200kVA
- Hydro-generators up to 25,000kVA
- Turbo-generators up to 62,500kVA

Power Transformers

- Built and engineered in North America
- Voltages < 500kV
- Ratings 5-300MVA
- Station class, oil filled, round core, copper windings
- Special configurations and designs available!
- Ask your WEG Sales Representative for details.
- Designed, built, and engineered to ANSI standards.

Custom Solution Package Sales

- WEG can package any of its products for ease of sale! Enjoy a single point of contact for the entire package of products and assistance from quote through after-sales support. Ask your WEG Sales Representative for details.



WEG Canada / VJ Pamensky
 64 Samor Road, Toronto, ON,
 M6A 1J6, Canad
 Phone: +1-877-PAMENSKY (726-3675)
info@pamensky.com
www.pamensky.com

